



全漢企業股份有限公司

SPI Electronic Co., Ltd.

台灣桃園市建國東路 22 號
TEL : 886-3-375-9888
<http://www.fsp-group.com.tw>

No. 22, Jianguo E. Rd., Taoyuan City,
Taiwan, R.O.C.
FAX : 886-3-375-6966
Email:sales@mail.fsp-group.com.tw

MECHANICAL DRAWING



Released Date:2006/4/28-13:28:31

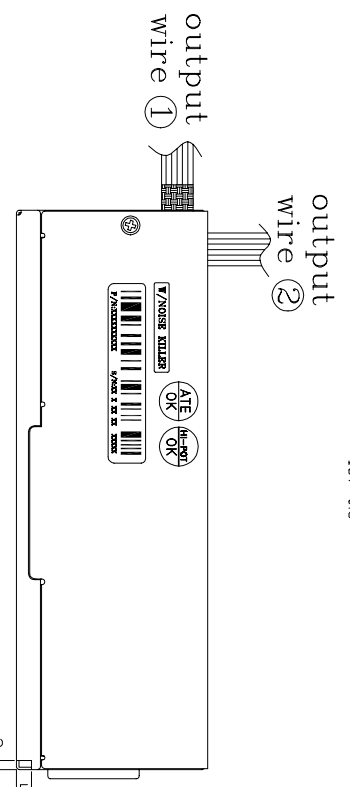
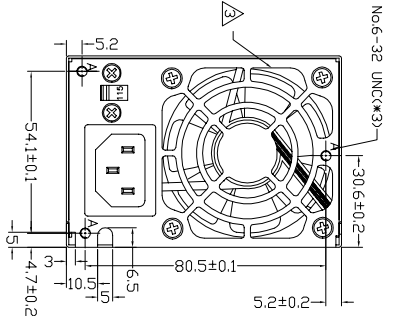
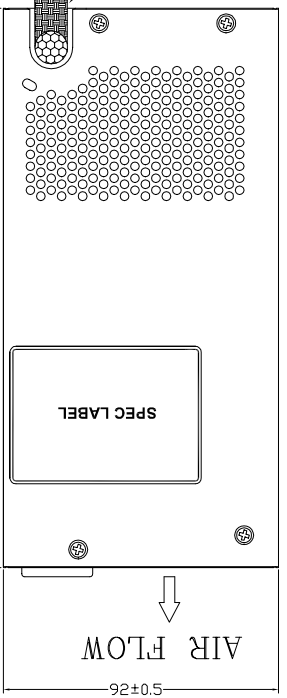
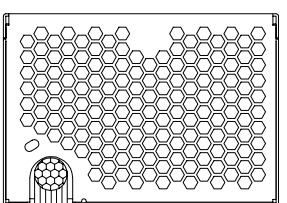
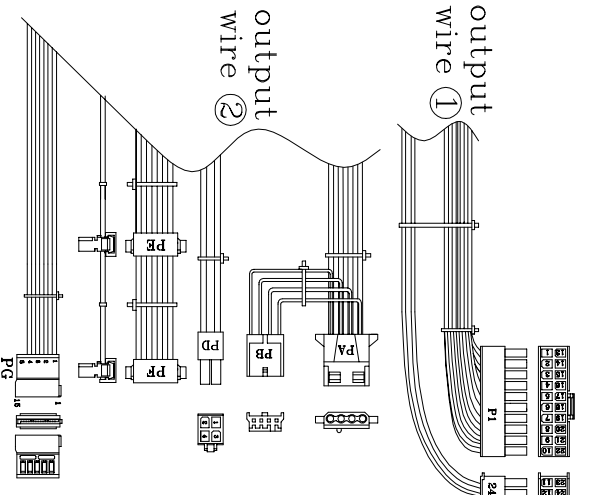
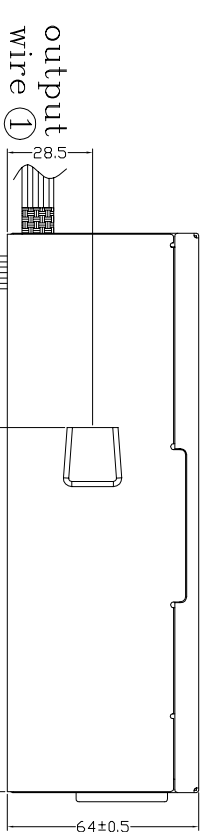
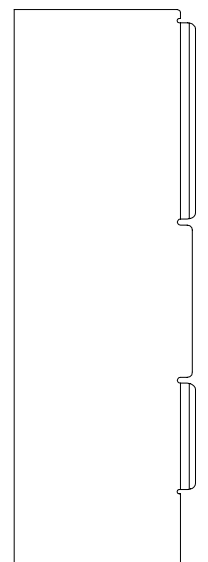

UNIT:mm

NOTE:
1. ALL THE LENGTH OF OUTPUT WIRES EXCLUDE HOUSING.
2. 產地標籤依業務指示加貼。

REF. ID	PIN NO.	SIGNAL	WIRE COLOR	GAUGE	CONNECTOR TYPE	CABLE LENGTH
P1	1	+3.3VDC	ORANGE	20	LTT H756-20N/04N OR EQUIVALENT	350 +30 mm -10 mm
	2	+3.3VDC	ORANGE	20		
	3	COM	BLACK	20		
	4	+5VDC	RED	20		
	5	COM	BLACK	20		
	6	+5VDC	RED	20		
	7	COM	BLACK	20		
	8	PW-OK	GRAY	24		
	9	+5Vsb	PURPLE	20		
	10	+12VDC	YELLOW	20		
	11	+12VDC	YELLOW	20		
	12	+3.3VDC	ORANGE	20		
	13	+3.3VDC	ORANGE	20		
	14	SENSE	BROWN	24		
	15	-12VDC	BLUE	24		
	16	COM	BLACK	20		
	17	PS-ON	GREEN	24		
	18	COM	BLACK	20		
	19	COM	BLACK	20		
	20	COM	BLACK	20		
21	+5VDC	RED	20			
22	+5VDC	RED	20			
23	+5VDC	RED	20			
24	COM	BLACK	20			
PA	1	+12V	YELLOW	20	AMP 1-48042-0 or Eqiv.	250 +30 mm -10 mm
	2	COM	BLACK	20		
	3	COM	BLACK	20		
	4	+5V	RED	20		
PB	1	+12V	YELLOW	22	AMP 171822-4 or Eqiv.	150 +10 mm -10 mm
	2	COM	BLACK	22		
	3	COM	BLACK	22		
	4	+5V	RED	22		
PD	1	COM	BLACK	20	MOLEX 39-01-2040 or Eqiv.	350 +30 mm +10 mm
	2	COM	BLACK	20		
	3	+12V	YELLOW	20		
	4	+12V	YELLOW	18		
PF	1	+12V	YELLOW	18	MOLEX 15-24-2004 or Eqiv.	150 +10 mm -10 mm
	2	COM	BLACK	18		
	3	COM	BLACK	18		
	4	+5V	RED	18		
PG	1	+12V	YELLOW	20	SPRALL 15PIN ATA	350 +30 mm -10 mm
	2	COM	BLACK	20		
	3	+5V	RED	20		
	4	COM	BLACK	20		

P/N.:9PA300C500

MODEL NO.:	FSP300-50GLV(W031)	TITLE: ASSY	SHEET: 1 OF 1	REV: 03
R&D	PE	DRAWN	DATE	
INTERIOR COUNTERSIGN:			APR.27.2006	