

**SC SERIES ENCLOSURES
NEMA 1 SCREW COVER WALL-MOUNT**



SC060604
with SCF cover



SC080806G



SC080806NK

Industry Standards

- UL 50, Type 1
- CSA Certified, Type 1 (See Note)
- NEMA/EEMAC Type 1

UL Files E23553

CSA File LL66078

FEATURES-SPECIFICATIONS

Applications

Designed for use as a junction box and pull box in commercial and general industrial applications. Flush covers must be ordered separately for flush mount applications.

Construction

- Fabricated from 16, 14 and 12 gauge steel or G-90 pre-galvanized steel (reference table)
- Flat, removable covers fastened with plated steel screws

- Cover design permits easy removal without extracting cover screws
- Mounting holes on back of box
- Available with or without knockouts. Removable concentric knockouts on all four sides of standard enclosures with knockouts

Finish

- ANSI-61 gray polyester powder inside and out
- Unpainted pre-galvanized steel

Accessories

- See pages J1-J22

Optional Flush Covers

Designed to mount on enclosure for flush installations. 16 or 14 gauge steel (reference table).

- ANSI 61 gray polyester powder finish.
- Unpainted pre-galvanized steel

| SC SERIES SCREW COVER PULL BOX ENCLOSURES | | | | | | | | |
|---|---------------|-------------|---------------|-----------------------------|-------------------------------|---|------------------|-----------------|
| CATALOG NUMBER | | | | BODY/DOOR STEEL GAUGE | COVERS ONLY See Page A5 | ENCLOSURE SIZE H+1/8", W+1/8", D+3/16" | KNOCKOUT PATTERN | |
| PAINTED | | GALVANIZED | | | | | WIDTH SIDE | HEIGHT SIDE |
| W/KNOCKOUTS | W/O KNOCKOUTS | W/KNOCKOUTS | W/O KNOCKOUTS | | | | | |
| SC040404* | SC040404NK* | SC040404G* | SC040404GNK* | 16/16 | Yes | 4.00x4.00x4.00 (102x102x102) | A | A |
| SC040604* | SC040604NK* | SC040604G* | SC040604GNK* | 16/16 | Yes | 6.00x4.00x4.00 (152x102x102) | A | A-B-A |
| SC060604 | SC060604NK | SC060604G | SC060604GNK | 16/16 | Yes | 6.00x6.00x4.00 (152x152x102) | A-B-A | A-B-A |
| SC060804 | SC060804NK | SC060804G | SC060804GNK | 16/16 | Yes | 8.00x6.00x4.00 (203x152x102) | A-B-A | A-B-A |
| SC061204 | SC061204NK | SC061204G | SC061204GNK | 16/16 | Yes | 12.00x6.00x4.00 (305x152x102) | A-B-A | B-A-F-F-A-B |
| SC080804 | SC080804NK | SC080804G | SC080804GNK | 16/16 | Yes | 8.00x8.00x4.00 (203x203x102) | A-B-A | A-B-A |
| SC081004 | SC081004NK | SC081004G | SC081004GNK | 16/16 | Yes | 10.00x8.00x4.00 (254x203x102) | A-B-A | B-A-F-F-A |
| SC081204 | SC081204NK | SC081204G | SC081204GNK | 16/16 | Yes | 12.00x8.00x4.00 (305x203x102) | A-B-A | B-A-F-F-A-B |
| SC101004 | SC101004NK | SC101004G | SC101004GNK | 16/16 | Yes | 10.00x10.00x4.00 (254x254x102) | B-A-F-F-A | B-A-F-F-A |
| SC101204 | SC101204NK | SC101204G | SC101204GNK | 16/16 | Yes | 12.00x10.00x4.00 (305x254x102) | B-A-F-F-A | B-A-F-F-A-B |
| SC121204 | SC121204NK | SC121204G | SC121204GNK | 16/16 | Yes | 12.00x12.00x4.00 (305x305x102) | B-A-F-F-A-B | B-A-F-F-A-B |
| SC121504 | SC121504NK | SC121504G | SC121504GNK | 16/16 | Yes | 15.00x12.00x4.00 (381x305x102) | B-A-F-F-A-B | A-B-A-F-F-A-B-A |

*Not UL Listed.

Continued on page A3

**SC SERIES ENCLOSURES
NEMA 1 SCREW COVER WALL-MOUNT**

| SC SERIES SCREW COVER PULL BOX ENCLOSURES (CONT.) | | | | | | | | |
|---|---------------|-------------|---------------|-----------------------------|-------------------------------|---|------------------|-----------------|
| CATALOG NUMBER | | | | BODY/DOOR STEEL GAUGE | COVERS ONLY See Page A5 | ENCLOSURE SIZE H- $\frac{1}{8}$ ", W- $\frac{1}{8}$ ", D- $\frac{3}{16}$ " | KNOCKOUT PATTERN | |
| PAINTED | | GALVANIZED | | | | | WIDTH SIDE | HEIGHT SIDE |
| W/KNOCKOUTS | W/O KNOCKOUTS | W/KNOCKOUTS | W/O KNOCKOUTS | | | | | |
| SC121804 | SC121804NK | SC121804G | SC121804GNK | 16/16 | Yes | 18.00x12.00x4.00 (457x305x102) | B-A-F-F-A-B | A-B-A-F-F-A-B-A |
| SC122404 | SC122404NK | SC122404G | SC122404GNK | 16/16 | Yes | 24.00x12.00x4.00 (610x305x102) | B-A-F-F-A-B | A-B-A-F-F-A-B-A |
| SC151504 | SC151504NK | SC151504G | SC151504GNK | 16/16 | Yes | 15.00x15.00x4.00 (381x381x102) | A-B-A-F-F-A-B-A | A-B-A-F-F-A-B-A |
| SC151804 | SC151804NK | SC151804G | SC151804GNK | 16/16 | Yes | 18.00x15.00x4.00 (457x381x102) | A-B-A-F-F-A-B-A | A-B-A-F-F-A-B-A |
| SC181804 | SC181804NK | SC181804G | SC181804GNK | 16/16 | Yes | 18.00x18.00x4.00 (457x457x102) | A-B-A-F-F-A-B-A | A-B-A-F-F-A-B-A |
| SC182404 | SC182404NK | SC182404G | SC182404GNK | 16/16 | Yes | 24.00x18.00x4.00 (610x457x102) | A-B-A-F-F-A-B-A | A-B-A-F-F-A-B-A |
| SC183004 | SC183004NK | SC183004G | SC183004GNK | 16/16 | Yes | 30.00x18.00x4.00 (762x457x102) | A-B-A-F-F-A-B-A | A-B-A-F-F-A-B-A |
| SC242404 | SC242404NK | SC242404G | SC242404GNK | 14/14 | Yes | 24.00x24.00x4.00 (610x610x102) | A-B-A-F-F-A-B-A | A-B-A-F-F-A-B-A |
| SC060606 | SC060606NK | SC060606G | SC060606GNK | 16/16 | Yes | 6.00x6.00x6.00 (152x152x152) | A-B-A | A-B-A |
| SC060806 | SC060806NK | SC060806G | SC060806GNK | 16/16 | Yes | 8.00x6.00x6.00 (203x152x152) | A-B-A | A-B-A |
| SC061206 | SC061206NK | SC061206G | SC061206GNK | 16/16 | Yes | 12.00x6.00x6.00 (305x152x152) | A-B-A | B-A-F-F-A-B |
| SC080806 | SC080806NK | SC080806G | SC080806GNK | 16/16 | Yes | 8.00x8.00x6.00 (203x203x152) | A-B-A | A-B-A |
| SC081006 | SC081006NK | SC081006G | SC081006GNK | 16/16 | Yes | 10.00x8.00x6.00 (254x203x152) | A-B-A | B-A-F-F-A |
| SC081206 | SC081206NK | SC081206G | SC081206GNK | 16/16 | Yes | 12.00x8.00x6.00 (305x203x152) | A-B-A | B-A-F-F-A-B |
| SC101006 | SC101006NK | SC101006G | SC101006GNK | 16/16 | Yes | 10.00x10.00x6.00 (254x254x152) | B-A-F-F-A | B-A-F-F-A |
| SC101206 | SC101206NK | SC101206G | SC101206GNK | 16/16 | Yes | 12.00x10.00x6.00 (305x254x152) | B-A-F-F-A | B-A-F-F-A-B |
| SC121206 | SC121206NK | SC121206G | SC121206GNK | 16/16 | Yes | 12.00x12.00x6.00 (305x305x152) | B-A-F-F-A-B | B-A-F-F-A-B |
| SC121506 | SC121506NK | SC121506G | SC121506GNK | 16/16 | Yes | 15.00x12.00x6.00 (381x305x152) | B-A-F-F-A-B | A-B-A-F-F-A-B-A |
| SC121806 | SC121806NK | SC121806G | SC121806GNK | 16/16 | Yes | 18.00x12.00x6.00 (457x305x152) | B-A-F-F-A-B | A-B-A-F-F-A-B-A |
| SC122406 | SC122406NK | SC122406G | SC122406GNK | 16/16 | Yes | 24.00x12.00x6.00 (610x305x152) | B-A-F-F-A-B | A-B-A-F-F-A-B-A |

Note: Must specify CSA Label when ordering.
Consult factory for dimensions and drawings
on 8", 10" and 12" deep enclosures.

Note: 8", 10" and 12" deep
enclosures do not have mounting
embosses in back of enclosure,
only mounting holes.

Continued on page A4

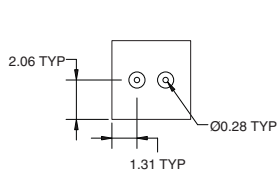

4.00" X 4.00" MOUNTING

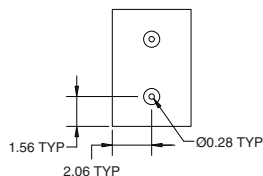

4.00" X 6.00" MOUNTING

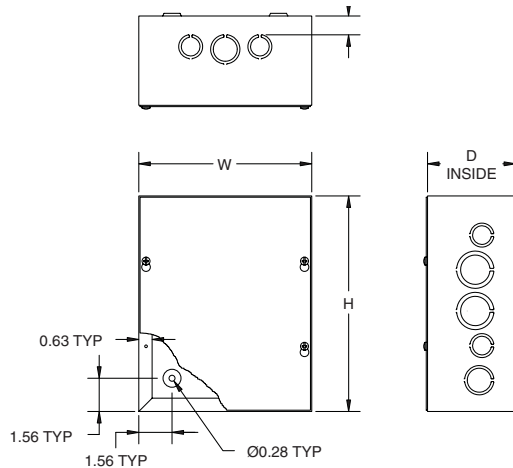

Knockout Patterns

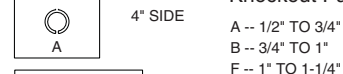

4" SIDE

- A -- 1/2" TO 3/4"
- B -- 3/4" TO 1"
- F -- 1" TO 1-1/4"

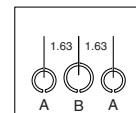

6" & 8" SIDE

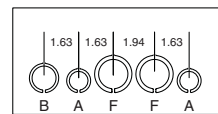

10" SIDE

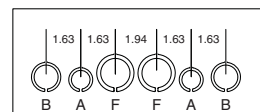

12" SIDE

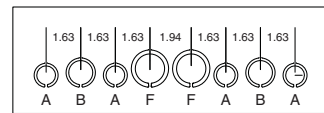

15", 18", 24",
30" & 36" SIDE.

**SC SERIES ENCLOSURES
NEMA 1 SCREW COVER WALL-MOUNT**

| SC SERIES SCREW COVER PULL BOX ENCLOSURES (CONT.) | | | | | | | | |
|---|---------------|-------------|---------------|-----------------------------|-------------------------------|---|------------------|-----------------|
| CATALOG NUMBER | | | | BODY/DOOR STEEL GAUGE | COVERS ONLY See Page A5 | ENCLOSURE SIZE H+1/8", W+1/8", D+3/16" | KNOCKOUT PATTERN | |
| PAINTED | | GALVANIZED | | | | | WIDTH SIDE | HEIGHT SIDE |
| W/KNOCKOUTS | W/O KNOCKOUTS | W/KNOCKOUTS | W/O KNOCKOUTS | | | | | |
| SC151506 | SC151506NK | SC151506G | SC151506GNK | 16/16 | Yes | 15.00x15.00x6.00 (381x381x152) | A-B-A-F-F-A-B-A | A-B-A-F-F-A-B-A |
| SC151806 | SC151806NK | SC151806G | SC151806GNK | 16/16 | Yes | 18.00x15.00x6.00 (457x381x152) | A-B-A-F-F-A-B-A | A-B-A-F-F-A-B-A |
| SC181806 | SC181806NK | SC181806G | SC181806GNK | 16/16 | Yes | 18.00x18.00x6.00 (457x457x152) | A-B-A-F-F-A-B-A | A-B-A-F-F-A-B-A |
| SC182406 | SC182406NK | SC182406G | SC182406GNK | 16/16 | Yes | 24.00x18.00x6.00 (610x457x152) | A-B-A-F-F-A-B-A | A-B-A-F-F-A-B-A |
| SC242406 | SC242406NK | SC242406G | SC242406GNK | 14/14 | Yes | 24.00x24.00x6.00 (610x610x152) | A-B-A-F-F-A-B-A | A-B-A-F-F-A-B-A |
| SC243006 | SC243006NK | SC243006G | SC243006GNK | 14/14 | No | 30.00x24.00x6.00 (762x610x152) | A-B-A-F-F-A-B-A | A-B-A-F-F-A-B-A |
| +SC080808 | +SC080808NK | +SC080808G | +SC080808GNK | 16/16 | Yes | 8.00x8.00x8.00 (203x203x203) | A-B-A | A-B-A |
| +SC121208 | +SC121208NK | +SC121208G | +SC121208GNK | 16/16 | Yes | 12.00x12.00x8.00 (305x305x203) | B-A-F-F-A-B | B-A-F-F-A-B |
| +SC121608 | +SC121608NK | +SC121608G | +SC121608GNK | 16/16 | No | 16.00x12.00x8.00 (406x305x203) | B-A-F-F-A-B | A-B-A-F-F-A-B-A |
| +SC121808 | +SC121808NK | +SC121808G | +SC121808GNK | 16/16 | Yes | 18.00x12.00x8.00 (457x305x203) | B-A-F-F-A-B | A-B-A-F-F-A-B-A |
| +SC122408 | +SC122408NK | +SC122408G | +SC122408GNK | 16/16 | Yes | 24.00x12.00x8.00 (610x305x203) | B-A-F-F-A-B | A-B-A-F-F-A-B-A |
| +SC181808 | +SC181808NK | +SC181808G | +SC181808GNK | 16/16 | Yes | 18.00x18.00x8.00 (457x457x203) | A-B-A-F-F-A-B-A | A-B-A-F-F-A-B-A |
| +SC182408 | +SC182408NK | +SC182408G | +SC182408GNK | 16/16 | Yes | 24.00x18.00x8.00 (610x457x203) | A-B-A-F-F-A-B-A | A-B-A-F-F-A-B-A |
| +SC242408 | +SC242408NK | +SC242408G | +SC242408GNK | 14/14 | Yes | 24.00x24.00x8.00 (610x610x203) | A-B-A-F-F-A-B-A | A-B-A-F-F-A-B-A |
| +SC243008 | +SC243008NK | +SC243008G | +SC243008GNK | 14/14 | No | 30.00x24.00x8.00 (762x610x203) | A-B-A-F-F-A-B-A | A-B-A-F-F-A-B-A |
| +SC243608 | +SC243608NK | +SC243608G | +SC243608GNK | 14/14 | No | 36.00x24.00x8.00 (914x610x203) | A-B-A-F-F-A-B-A | A-B-A-F-F-A-B-A |
| — | +SC303008NK | — | +SC303008GNK | 12/12 | No | 30.00x30.00x8.00 (762x762x203) | A-B-A-F-F-A-B-A | A-B-A-F-F-A-B-A |
| — | +SC303608NK | — | +SC303608GNK | 12/12 | No | 36.00x30.00x8.00 (914x762x203) | A-B-A-F-F-A-B-A | A-B-A-F-F-A-B-A |
| — | +SC363608NK | — | +SC363608GNK | 12/12 | No | 36.00x36.00x8.00 (914x914x203) | A-B-A-F-F-A-B-A | A-B-A-F-F-A-B-A |
| +SC121210 | +SC121210NK | +SC121210G | +SC121210GNK | 16/16 | Yes | 12.00x12.00x10.00 (305x305x254) | B-A-F-F-A-B | B-A-F-F-A-B |
| +SC121810 | +SC121810NK | +SC121810G | +SC121810GNK | 16/16 | Yes | 18.00x12.00x10.00 (457x305x254) | B-A-F-F-A-B | A-B-A-F-F-A-B-A |
| +SC122410 | +SC122410NK | +SC122410G | +SC122410GNK | 16/16 | Yes | 24.00x12.00x10.00 (610x305x254) | B-A-F-F-A-B | A-B-A-F-F-A-B-A |
| +SC181810 | +SC181810NK | +SC181810G | +SC181810GNK | 16/16 | Yes | 18.00x18.00x10.00 (457x457x254) | A-B-A-F-F-A-B-A | A-B-A-F-F-A-B-A |
| +SC182410 | +SC182410NK | +SC182410G | +SC182410GNK | 16/16 | Yes | 24.00x18.00x10.00 (610x457x254) | A-B-A-F-F-A-B-A | A-B-A-F-F-A-B-A |
| +SC242410 | +SC242410NK | +SC242410G | +SC242410GNK | 14/14 | Yes | 24.00x24.00x10.00 (610x610x254) | A-B-A-F-F-A-B-A | A-B-A-F-F-A-B-A |
| +SC243010 | +SC243010NK | +SC243010G | +SC243010GNK | 14/14 | No | 30.00x24.00x10.00 (762x610x254) | A-B-A-F-F-A-B-A | A-B-A-F-F-A-B-A |
| — | +SC303010NK | — | +SC303010GNK | 12/12 | No | 30.00x30.00x10.00 (762x762x254) | A-B-A-F-F-A-B-A | A-B-A-F-F-A-B-A |
| — | +SC303610NK | — | +SC303610GNK | 12/12 | No | 36.00x30.00x10.00 (914x762x254) | A-B-A-F-F-A-B-A | A-B-A-F-F-A-B-A |
| +SC243610 | +SC243610NK | +SC243610G | +SC243610GNK | 14/14 | No | 36.00x24.00x10.00 (914x610x254) | A-B-A-F-F-A-B-A | A-B-A-F-F-A-B-A |
| — | +SC363610NK | — | +SC363610GNK | 12/12 | No | 36.00x36.00x10.00 (914x914x254) | A-B-A-F-F-A-B-A | A-B-A-F-F-A-B-A |
| +SC121212 | +SC121212NK | +SC121212G | +SC121212GNK | 16/16 | Yes | 12.00x12.00x12.00 (305x305x305) | B-A-F-F-A-B | B-A-F-F-A-B |

(+) All products, unless otherwise denoted by a (+), are: H+1/8", W+1/8", D+3/16"

Continued on page A5

SC SERIES ENCLOSURES NEMA 1 SCREW COVER WALL-MOUNT

A5

| SC SERIES SCREW COVER PULL BOX ENCLOSURES (CONT.) | | | | | | | | |
|---|---------------|-------------|---------------|-----------------------------|-----------------------------------|---|------------------|-----------------|
| CATALOG NUMBER | | | | BODY/DOOR STEEL GAUGE | COVERS ONLY See Chart Below | ENCLOSURE SIZE H+ $\frac{1}{8}$ ", W+ $\frac{1}{8}$ ", D+ $\frac{3}{16}$ " | KNOCKOUT PATTERN | |
| PAINTED | | GALVANIZED | | | | | WIDTH SIDE | HEIGHT SIDE |
| W/KNOCKOUTS | W/O KNOCKOUTS | W/KNOCKOUTS | W/O KNOCKOUTS | | | | | |
| + SC122412 | + SC122412NK | + SC122412G | + SC122412GNK | 16/16 | Yes | 24.00x12.00x12.00 (610x305x305) | B-A-F-F-A-B | A-B-A-F-F-A-B-A |
| + SC181812 | + SC181812NK | + SC181812G | + SC181812GNK | 16/16 | Yes | 18.00x18.00x12.00 (457x457x305) | A-B-A-F-F-A-B-A | A-B-A-F-F-A-B-A |
| + SC182412 | + SC182412NK | + SC182412G | + SC182412GNK | 16/16 | Yes | 24.00x18.00x12.00 (610x457x305) | A-B-A-F-F-A-B-A | A-B-A-F-F-A-B-A |
| + SC242412 | + SC242412NK | + SC242412G | + SC242412GNK | 14/14 | Yes | 24.00x24.00x12.00 (610x610x305) | A-B-A-F-F-A-B-A | A-B-A-F-F-A-B-A |
| + SC243012 | + SC243012NK | + SC243012G | + SC243012GNK | 14/14 | No | 30.00x24.00x12.00 (762x610x305) | A-B-A-F-F-A-B-A | A-B-A-F-F-A-B-A |
| + SC243612 | + SC243612NK | + SC243612G | + SC243612GNK | 14/14 | No | 36.00x24.00x12.00 (914x610x305) | A-B-A-F-F-A-B-A | A-B-A-F-F-A-B-A |
| — | + SC303012NK | — | + SC303012GNK | 12/12 | No | 30.00x30.00x12.00 (762x762x305) | A-B-A-F-F-A-B-A | A-B-A-F-F-A-B-A |
| — | + SC303612NK | — | + SC303612GNK | 12/12 | No | 36.00x30.00x12.00 (914x762x305) | A-B-A-F-F-A-B-A | A-B-A-F-F-A-B-A |
| — | + SC363612NK | — | + SC363612GNK | 12/12 | No | 36.00x36.00x12.00 (914x914x305) | A-B-A-F-F-A-B-A | A-B-A-F-F-A-B-A |

(+) All products, unless otherwise denoted by a (+), are: H+1/8", W+1/8", D+3/16"

Note: Must specify CSA Label when ordering. Consult factory for dimensions and drawings on 8", 10" and 12" deep enclosures.

Note: 8", 10" and 12" deep enclosures do not have mounting embosses in back of enclosure, only mounting holes.

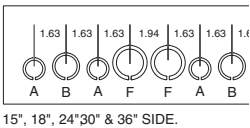
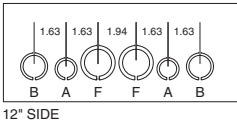
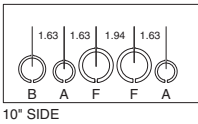
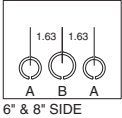
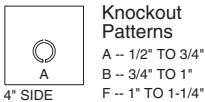

| SURFACE & FLUSH COVERS ONLY | | | | FLUSH COVER SIZE A X B | FOR BOX SIZE H X W** |
|-----------------------------|---------------|---------------|-------------|---------------------------|-------------------------|
| SURFACE PNTD. | SURFACE GALV. | FLUSH PAINTED | FLUSH GALV. | | |
| SC0404 | SC0404G | SCF0404 | SCF0404G | 6.00x6.00 (152x152) | 4.00x4.00 (102x102) |
| SC0406 | SC0406G | SCF0406 | SCF0406G | 8.00x6.00 (203x152) | 6.00x4.00 (102x102) |
| SC0606 | SC0606G | SCF0606 | SCG0606G | 8.00x8.00 (203x203) | 6.00x6.00 (152x152) |
| SC0608 | SC0608G | SCF0608 | SCF0608G | 10.00x8.00 (254x203) | 8.00x6.00 (203x152) |
| SC0612 | SC0612G | SCF0612 | SCF0612G | 14.00x8.00 (356x203) | 12.00x6.00 (305x152) |
| SC0808 | SC0808G | SCF0808 | SCF0808G | 10.00x10.00 (254x254) | 8.00x8.00 (203x203) |
| SC0810 | SC0810G | SCF0810 | SCF0810G | 12.00x10.00 (305x254) | 10.00x8.00 (254x203) |
| SC0812 | SC0812G | SCF0812 | SCF0812G | 14.00x10.00 (356x254) | 12.00x8.00 (305x203) |
| SC1010 | SC1010G | SCF1010 | SCF1010G | 12.00x12.00 (305x305) | 10.00x10.00 (254x254) |
| SC1012 | SC1012G | SCF1012 | SCF1012G | 14.00x12.00 (356x305) | 12.00x10.00 (305x254) |
| SC1212 | SC1212G | SCF1212 | SCF1212G | 14.00x14.00 (356x356) | 12.00x12.00 (305x305) |
| SC1215 | SC1215G | SCF1215 | SCF1215G | 17.00x14.00 (432x356) | 15.00x12.00 (381x305) |
| SC1216 | SC1216G | SCF1216 | SCF1216G | 18.00x14.00 (457x356) | 16.00x12.00 (406x305) |
| SC1218 | SC1218G | SCF1218 | SCF1218G | 20.00x14.00 (508x356) | 18.00x12.00 (457x305) |
| SC1224 | SC1224G | SCF1224 | SCF1224G | 26.00x14.00 (660x356) | 24.00x12.00 (610x305) |
| SC1515 | SC1515G | SCF1515 | SCF1515G | 17.00x17.00 (432x432) | 15.00x15.00 (381x381) |
| SC1518 | SC1518G | SCF1518 | SCF1518G | 20.00x17.00 (508x432) | 18.00x15.00 (457x381) |
| SC1616 | SC1616G | SCF1616 | SCF1616G | 18.00x18.00 (457x457) | 16.00x16.00 (406x406) |
| SC1818 | SC1818G | SCF1818 | SCF1818G | 20.00x20.00 (508x508) | 18.00x18.00 (457x457) |
| SC1824 | SC1824G | SCF1824 | SCF1824G | 26.00x20.00 (660x508) | 24.00x18.00 (610x457) |
| SC1830 | SC1830G | SCF1830 | SCF1830G | 32.00x20.00 (813x508) | 30.00x18.00 (762x457) |
| SC2424 | SC2424G | SCF2424 | SCF2424G | 26.00x26.00 (660x660) | 24.00x24.00 (610x610) |

**Surface covers are same size as H x W of box.

